

MAJESTIC[®]

● Model: LED191DU

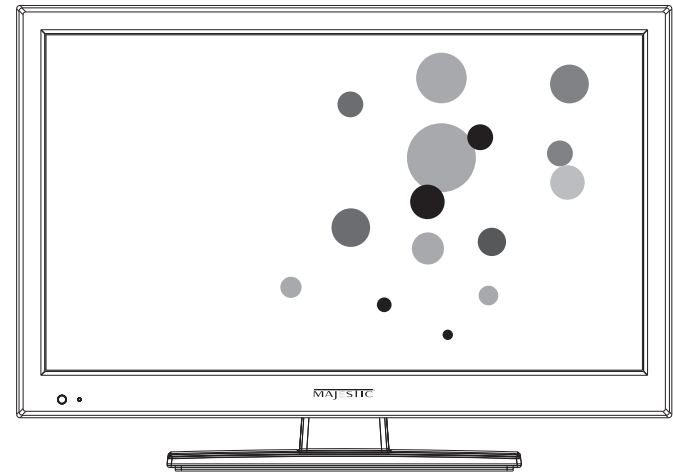

**LED TV/Combo
INSTRUCTION MANUAL**

Safety Information

IMPORTANT SAFETY INSTRUCTIONS

Read these instructions.
Keep these instructions.
Heed all warnings.
Follow all instructions.
Do not use this apparatus near water.
Clean only with dry cloth.
Do not block any ventilation openings. Install in accordance with the manufacturer's instructions.
Do not install near any heat sources such as radiators, heat registers, stoves, or other apparatus (including amplifiers) that produce heat.
Do not defeat the safety purpose of the polarized or grounding plug. A polarized plug has two blades with one wider than the other. A grounding plug has two blades and a third grounding prong. The wide blade or the third prong is provided for your safety. If the provided plug does not fit into your outlet, consult an electrician for replacement of the obsolete outlet.
Protect the power cord from being walked on or pinched particularly at the plugs, convenience receptacles, and at the point where they exit from the apparatus.
Only use attachments/accessories specified by the manufacturer.
Use only with the cart, stand, tripod, bracket, or table specified by the manufacturer, or sold with the apparatus. When a cart or rack is used, use caution when moving the cart/apparatus combination to avoid injury from tip-over.



Unplug the apparatus during lightning storms or when unused for long periods of time. Refer all servicing to qualified personnel. Servicing is required when the apparatus has been damaged in any way, such as power supply cord or plug is damaged, liquid has been spilled or objects have fallen into the apparatus has been exposed to rain or moisture, does not operate normally, or has been dropped.

CAUTION: These servicing instructions are for use by qualified service personnel only. To reduce the risk of electric shock, do not perform any servicing other than that contained in the operating instructions unless you are qualified to do so.

WARNING : To reduce the risk of fire or electric shock, do not expose this apparatus to rain or moisture. The apparatus shall not be exposed to dripping or splashing and that objects filled with liquids, such as vases, shall not be placed on apparatus.

WARNING: The mains plug is used as disconnect device, the disconnect device shall remain readily operable.



- This lightning flash with arrowhead symbol within an equilateral triangle is intended to alert the user to the presence of non-insulated "dangerous voltage" within the product's enclosure that may be of sufficient magnitude to constitute a risk of electric shock.

- Warning: To reduce the risk of electric shock, do not remove cover (or back) as there are no user-serviceable parts inside. Refer servicing to qualified personnel.

- The exclamation point within an equilateral triangle is intended to alert the user to the presence of important operating and maintenance instructions in the literature accompanying the appliance.

Apparatus with class I construction shall be connected to a mains socket outlet with a protective earthing connection.

Important Safety Precautions

Safety

Please, immediately pull out the AC power plug from adapter if there is an abnormal sound or smell or the LED TV has sound but no picture, and contact after sales support.



The LED TV should be kept free from rain, moisture and dust to prevent electrical shock and short circuits. Do not cover the ventilation openings with table clothes, curtains, newspapers, etc.

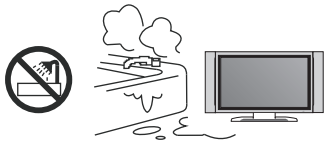

The LED TV should be kept from high temperature heating sources or direct sunlight. Good ventilation is required. Allow 10 cm. between the LED TV and other appliances or built-in cabinet walls.

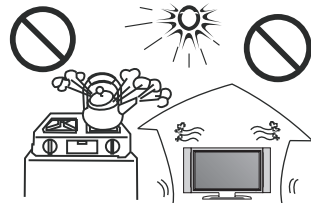

When you wipe the front cabinet, please make sure the power plug is pulled out and use a soft, dry, lint-free cloth and handle it with care. Do not repeatedly wipe the panel, nor scrape, tap or strike the panel with a hard object.

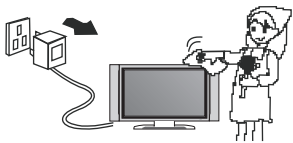

Do not wipe the LED TV with any petrol, chemical or alcohol based solvents as it will lead to product damage of the panel and cabinet.

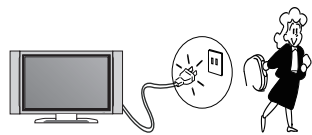

When the television receiver is not used for an extended period of time, it is advisable to disconnect the AC power cord from the AC outlet. The MAINS plug or an appliance coupler is used as the disconnect device. The disconnect device shall remain readily operable.

Important Safety Precautions

Safety

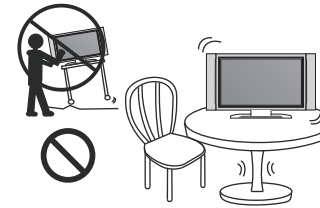

Do not place the LED TV on an unstable surface.

Do not place the power cord or other cables across a walkway in case it is trampled on. Do not overload the power cord or power socket. When the power plug is used to disconnect and connect the device, it should easily into the power source.

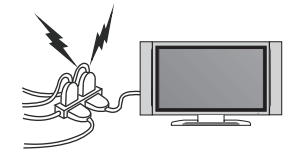

Do not disassemble the back cover, as it contains high voltages inside and will cause electric shock. Only qualified professionals should conduct internal adjustments, maintenance, and checks.

The TV set should not be subjected to water droplets, vapor, or splash. This equipment should not be placed on objects filled with liquids. Do not place flame sources, such as lit candles, on or near the LED TV. Please, pull out the power plug and contact after sales support if there are abnormal objects or water in the TV.

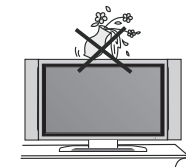

Pull out the power cord and antenna cable during electrical storms so the LED TV is not damaged by electrical surges. Keep all people away from the antenna cable during electrical storms.

Table of Contents

Introduction	
Features	2
Specifications	3
Accessories	4
General Description	4-7
Overview of front and side panel	4
Overview of back panel	5
Overview of remote control	6
External Connection	8
Connecting VCR	8
Connecting DVD Player/Set-Top Box	9
Connecting Digital Audio System	10
Connecting DVD Player/Set-Top Box via HDMI	11
Connecting PC	12
Basic operation	13
Turning the TV On and Off	13
OSD Menu Operations	14-18
BASIC OPERATION	14
CHANNEL	14
PICTURE	15
AUDIO	15
TIME	16
SETUP	16
LOCK	17-18
USB	19-21
USB Operation	19-21
DVD	22-23
DVD Setup Menu	22
DVD Operation	23
Troubleshooting	24
Picture defects and the reason	25

Introduction

Features

- TV adopts TFT LED display screen
- HDTV Compatible(480p,720p, 1080i, 1080p)
- Support American TV Standard 8VSB/Free 64/256QAM,NTSC System, ATSC System
- Connect to computer directly to realize TV/monitor combo.
- Zero X radiation complies to green environment protection requirement
- Advanced Chroma Processing
- Closed captioning/PARENTAL LOCK
- SAP/STEREO/MONO; ATSC.
- HDMI input
- USB input

Input terminals used for external equipment connection

One computer VGA/PC input	One PC Audio input
One AV input	Two HDMI input
One EARPHONE output	One USB input
One ANTENNA input	One Coaxial output
One YPbPr input	R/L Audio output

Introduction

Specifications

Display screen type	Color active matrix LED display
Model	LED191DU
The maximum resolution	1366X768
Image control	Fine digital control
Power supply	DC 12V \approx 4A
TV receive system	NTSC System, ATSC System
Frequency range	Antenna: 2~69; Cable: 1~135 (Analog: 1-125, Digital: 1-135)
Video IN	NTSC3,58
Antenna input impedance	75 Ω (Unbalance)
Sound output	2 x 5 W
Power supply for remote controller	DC 3V (Two AAA size batteries)
Power consumption	32 W
Operation environment temperature	0 $^{\circ}$ C-35 $^{\circ}$ C

Note:
Design and specification modification maybe made at any time without prior notice; all data and dimensions are approximations.

Accessories

Please make sure the following items are included with your LED TV. If any items are missing, contact your dealer.



Remote Control & Batteries (AAAx 2)

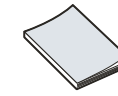

Owner's Instructions



Car charger cable



Adapter

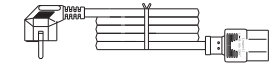

Power Cord

General Description

Overview of front and side panel

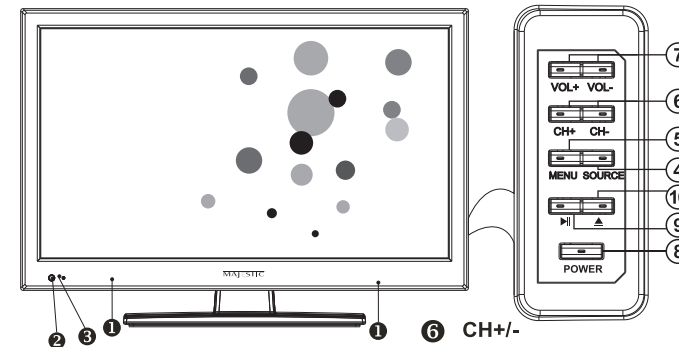

- 1 SPEAKER**
- 2 REMOTE CONTROL SENSOR**
Aim the remote control towards this spot on the TV.
- 3 POWER INDICATOR**
Green: In power on mode.
Red: In standby mode.
- 4 SOURCE**
Toggles between all the available input sources (TV, AV, Component, DVD, HDMI 1, HDMI 2, PC, USB)
- 5 MENU**
Press to see an on-screen menu of your TV's features.
- 6 CH+/-**
Press to change channels.
In the on-screen menu, use the CH +/- buttons as up/down arrow buttons.
- 7 VOL+/-**
Press to increase or decrease the volume.
In the on-screen menu, use the VOL +/- buttons as left/right arrow buttons.
- 8 POWER**
Press POWER button to toggle between normal and standby mode.
- 9** After placed a disc in the disc tray, press **▶||** button to play the disc, and press **▶||** button twice to pause.
- 10** Press the **▲** button when the power is on the disc will eject, Press **▲** button again the disc is pulled in automatically.

General Description

Overview of back panel

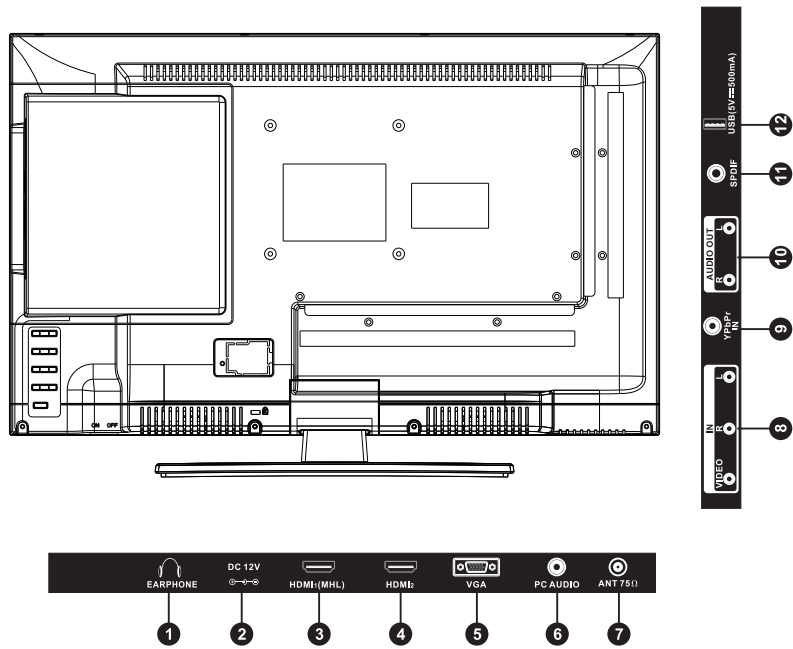

1. EARPHONE

Connect a set of phone for private listening.

2. POWER(DC 12V) input

Connect to the HDMI jack of a device with an HDMI output.

Connect with the phone(the phone with MHL function)port.

4. HDMI2

Connect to the HDMI jack of a device with an HDMI output.

5. VGA/PC IN

Connect to the video output jack on your PC.

6. PC AUDIO

Audio input for external devices

7. RF

Connect to an antenna or cable.

8. VIDEO

Video input for external devices, such as a camcorder or VCR.

9. COMPONENT

Connect Component video.

10.L/R

Connect to the audio output jacks on your amplifier/home theater.

11.COAXIAL

Connect to a Digital Audio devices.

12.USB

USB input(5V \equiv 500mA)

General Description

Overview of remote control

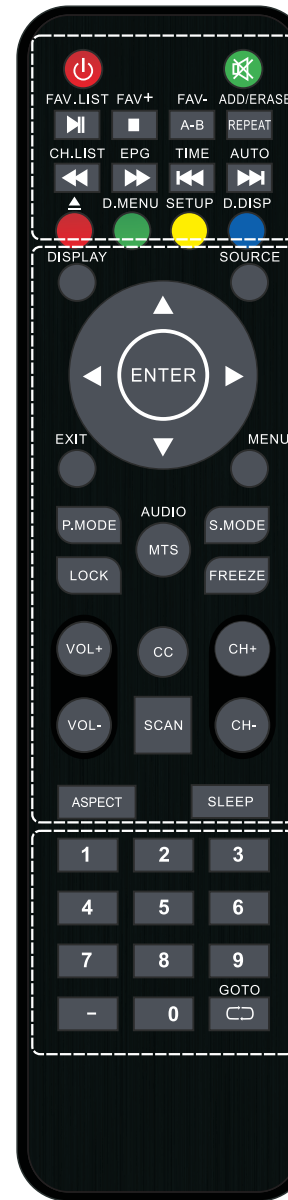

POWER: Turn the TV on or off.
MUTE: Press to mute the sound, Press again to regain the sound.
FAV.LIST: Press to display the favorite programs.
FAV+/-: Press this button +/- the favorite program list.
ADD: Add this program to the favorite language.
CH. LIST: Press to display the TV program CH. list.
EPG: Press to display EPG (Electronic Program Guide) in formation.
TIME: Press to display Time menu.
AUTO: Auto adjust in the PC mode.
▲: Open/close in DVD mode.
D.MENU: Quick navigation during Teletext or setup settings
DVD: Video DVD Menu button.
SETUP: DVD system setup.
D.DISP: Quick navigation during Teletext or setup settings
DVD: DVD Information button.
▶||: Play / Pause.
■: Stop playing.
A-B: Repeat play the segment between A and B.
REPEAT: Press to change the playing mode.
◀▶▶▶: Play fast backward / forward.
|◀▶▶|: Play previous / next media file.

DISPLAY: Press to display the program's in formation.
SOURCE: Press to select signal source for TV.
▲▼◀▶/ENTER: Allows you to navigate the on-screen menus and adjust the system settings to your preference.
EXIT: Exit from the menu or sub menu.
MENU: Allow you to navigate the on-screen menus.
P.MODE: Select the picture mode.
S.MODE: Select the sound mode.
LOCK: Press to display the parental menu.
MTS: Press to select the audio channels.
AUDIO: Press to display the language of the audio in DTV or DVD mode.
FREEZE: Press to freeze the screen.
VOL+/-: Press these two buttons to increase/decrease the sound volume.
CH+/-: Press these two buttons to change channels sequently.
CC: Press to display the closed caption.
SCAN: Press to Auto scan TV program.
ASPECT: Press this button to select the aspect of screen.
SLEEP: Set up the time how long the TV will turn off.

0-9: Press 0-9 to select a TV channel directly The channel will change after 2 seconds.
-: Press this button firstly when the channel to be selected is two or three figures.
↺: Return to the previously viewed program.
GOTO: Press this button to go to desired position The player provides 3 search mode.

General Description

Installing Batteries in the Remote Control

Installing Batteries

- 1 Open the battery compartment cover on the back side.

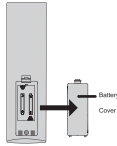

- 2 Insert two 1.5V AAA size batteries in correct polarity. Don't mix old or used batteries with new ones.

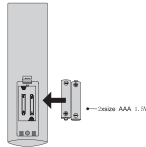

- 3 Closed the cover.

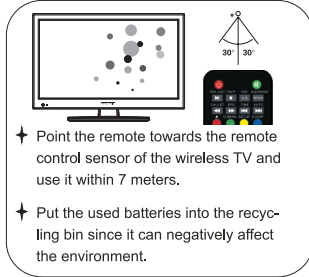
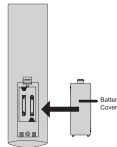

Note:

- One loading of batteries will last for 1 year under normal use
- If you do not intend to use the remote controller for a long period of time, remove them to avoid damage due to leakage.
- Do not use old and new batteries together.
- The battery (battery or batteries or battery pack) shall not be exposed to excessive heat such as sunshine, fire or the like.

External Connection

Antenna connection

Antenna input impedance of this unit is 75ohm. VHF/UHF 75ohm coaxial cable can be connected to the antenna jack directly, if the antenna cable is 300ohm parallel flat feeder cable, you need to use the 300ohm/75ohm converter to connect the antenna cable to the antenna jack. For details Please refer to the following drawing.

Antennas with 300ohm flat twins Leads

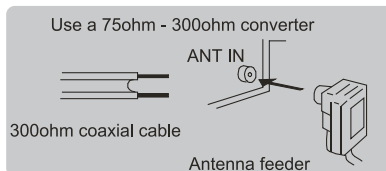

Antennas with 75ohm Round Leads

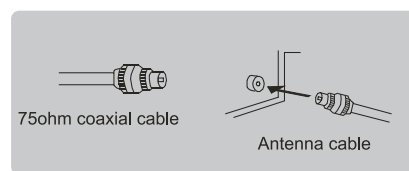

External Connection

Connecting VCR

These instructions assume that you have already connected your TV to an antenna or a cable TV system. Skip step 1 if you have not yet connected to an antenna or a cable system.

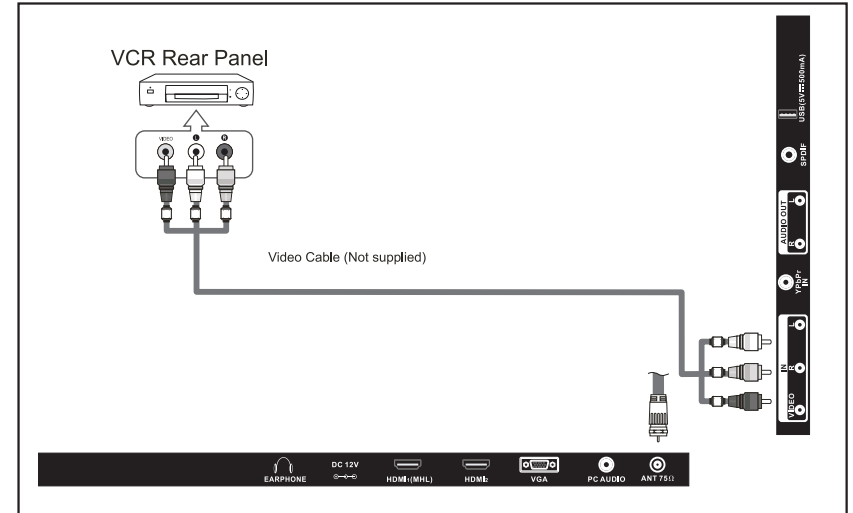

Follow the instructions in Viewing a VCR or Camcorder Tape to view your VCR tape. Each VCR has a different back panel configuration. When connecting a VCR, match the color of the connection terminal to the cable. We recommend the use of cables with a Ferrite Core.

1. Unplug the cable or antenna from the back of the TV.
2. Connect the cable or antenna to the ANT IN terminal on the back of the VCR.
3. Connect an RF Cable between the ANT OUT terminal on the VCR and the ANT IN terminal on the TV.
4. Connect a Video Cable between the VIDEO OUT jack on the VCR and the VIDEO IN jack on the TV.
5. Connect Audio Cables between the AUDIO OUT jacks on the VCR and the AUDIO L and AUDIO R jacks on the TV.
 - If you have a mono (non-stereo) VCR, use a Y-connector (not supplied) to hook up to the right and left audio input jacks of the TV. If your VCR is stereo, you must connect two cables.

External Connection

Connecting DVD Player/Set-Top Box

The rear panel jacks on your TV make it easy to connect a DVD to your TV.

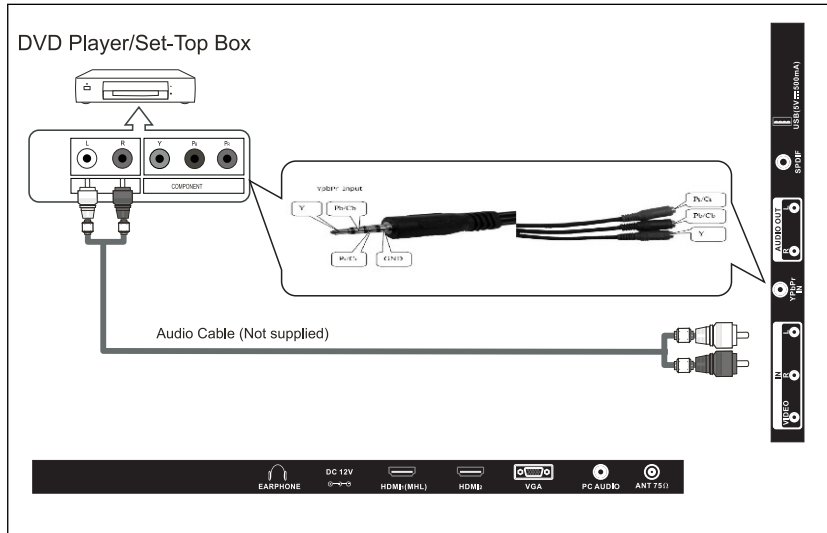

Component video separates the video into Y (Luminance (brightness)), Pb (Blue) and Pr (Red) for enhanced video quality.

Be sure to match the component video and audio connections.

For example, if connecting the video cable to COMPONENT IN, connect the audio cable to COMPONENT IN also.

Each DVD player/STB has a different back panel configuration.

When connecting a DVD player/STB, match the color of the connection terminal to the cable.

We recommend the use of cables with a Ferrite Core.

1. Connect a Component Cable between the COMPONENT IN [Y, PB, PR] jacks on the TV and the COMPONENT [Y, PB, PR] jacks on the DVD player.
2. Connect Audio Cables between the COMPONENT IN [R-AUDIO-L] jacks on the ATV and the AUDIO OUT jacks on the DVD player.

External Connection

Connecting Digital Audio System

The rear panel jacks on your TV make it easy to connect a Digital Audio System to your TV.

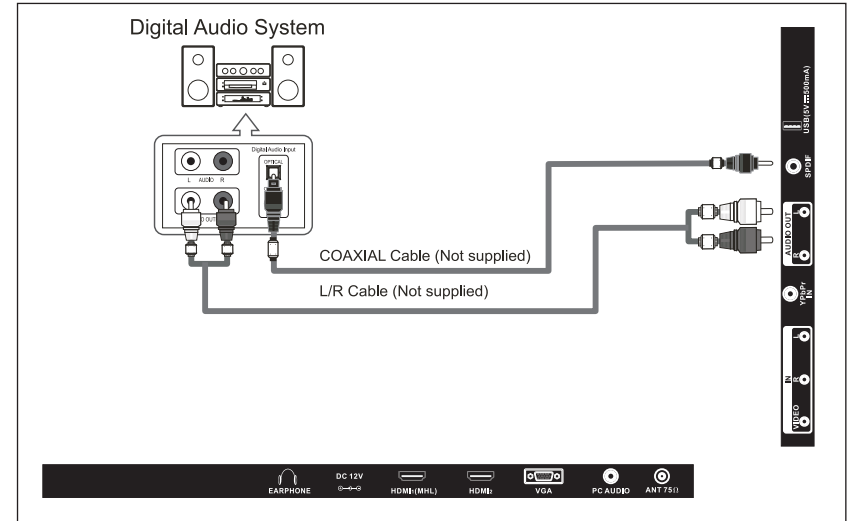

5.1 CH audio is possible when the TV is connected to an external device supporting 5.1 CH.

We recommend the use of cables with a Ferrite Core.

1. Connect an COAXIAL Cable between the SPDIF jacks on the TV and the Digital Audio Input jacks on the Digital Audio System. When a Digital Audio System is connected to the SPDIF terminal: Decrease the gain (volume) of the TV, and adjust the volume level with the system's volume control.

External Connection

Connecting DVD Player/Set-Top Box via HDMI

This connection can only be made if there is a HDMI Output connector on the external device.

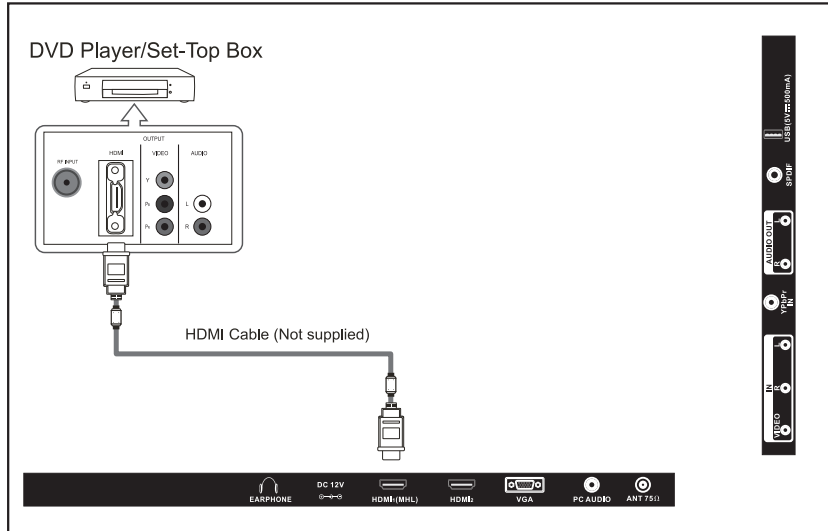

What is HDMI?

HDMI, or high-definition multimedia interface, is a next-generation interface that enables the transmission of digital audio and video signals using a single cable without compression.

Multimedia interface is a more accurate name for it especially because it allows multiple channels of digital audio (5.1 channels).

The difference between HDMI and DVI is that the HDMI device is smaller in size, has the HDCP(High Bandwidth Digital Copy Protection) coding feature installed, and supports multi-channel digital audio.

Each DVD player/STB has a different back panel configuration. We recommend the use of cables with a Ferrite Core.

1. Connect an HDMI Cable between the HDMI connector on the TV and the HDMI connector on the DVD player/Set-Top Box.

External Connection

Connecting PC

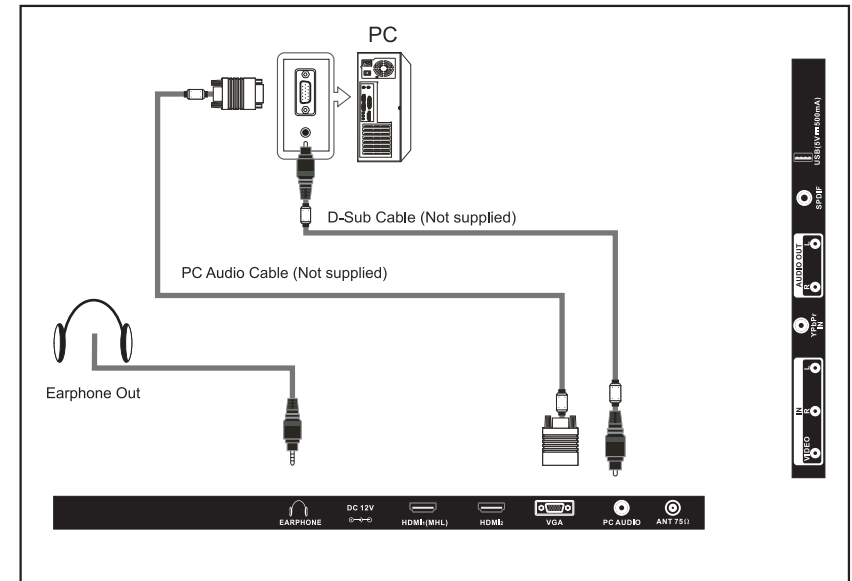

Each PC has a different back panel configuration.

The HDMI jacks do not support PC connection.

We recommend the use of cables with a Ferrite Core.

1. Connect a D-Sub Cable between RGB/PC IN connector on the TV and the PC output connector on your computer.
2. Plug PHONE out connector into PHONE out jack on the TV the TV speaker will be muted.
3. Connect the PC audio input jacks on the TV

Supporting signals

Input	Mode
Air	8VSB
Cable	Free 64/256QAM
CVBS	NTSC 3.58

VGA/PC	Component	HDMI
640x480/60Hz	480p/60Hz	480p/60Hz
800x600/60Hz	720p/60Hz	720p/60Hz
1024x768/60Hz	1080i/60Hz	1080i/60Hz
1360x768/60Hz	1080p/60Hz	1080p/60Hz

Basic Operation

Turning the TV On and Off

1 How to turn the TV on or off

1. Insert the power cord plug into a polarized AC outlet.
 2. Press POWER button on the remote control or ψ button on the LED TV.
 3. Normal picture will be displayed on the screen after 6 seconds. If no signal input, "No Signal" will be displayed on the screen.
 4. If temporary POWER off is required, press POWER button on the remote control or ψ button on the LED TV.
 5. If you want to completely switch off the power for this unit, unplug the power cord plug for this unit.
 6. After switching off the unit, you should turn on the TV again at least 5 seconds later.
- Status indication lamp
Green: In power on mode.
Red: In standby mode.
Auto power off

If there is no signal input in any Mode, the TV will automatically access the standby state in about 15 minutes.

Memory before turning TV off

The settings of picture and the preset channels will be memorized at turning off the unit.

When being started up again, the unit will work according to the mode set before being turned off.

OSD Menu Operations

Adjust the OSD Screen



Press SOURCE button to display the input source list. Press ∇/\blacktriangle button to select the input source you want to watch. Press ENTER button to enter the input source.

BASIC OPERATION

CHANNEL

Press MENU button to display the main menu.

Press $\blacktriangleleft/\blacktriangleright$ button to select CHANNEL in the main menu, it will highlight the first option.

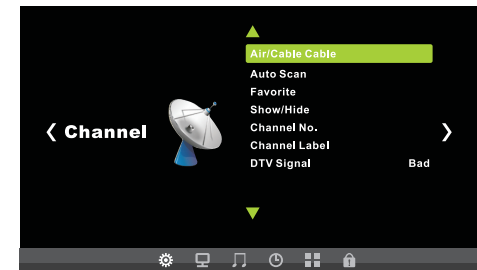

Air/Cable
press ENTER buttons to select it Cable or Air.
AUTO SCAN

Auto Tuning can find out all effective channel automatically. Press ∇/\blacktriangle to select Auto Tuning, then press ENTER to start auto searching.

If you want to stop searching, press EXIT.

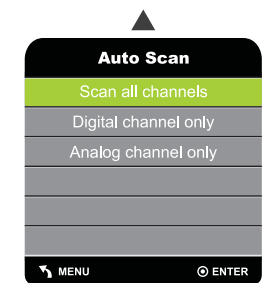

OSD Menu Operations

PICTURE

Press **MENU** button to display the main menu.

Press ◀ / ▶ button to select **PICTURE** in the main menu, it will highlight the first option.

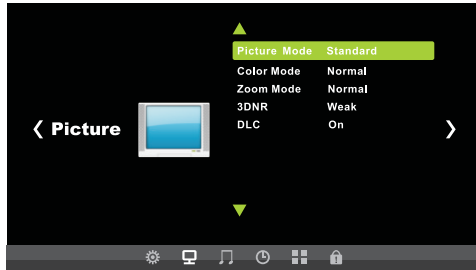

PICTURE MENU

Press **MENU** to display the main menu, and press ◀ / ▶ to select the Picture Menu.

Highlight the item and press ▼ / ▲ to select corresponding sub-menu.

Picture Mode: Dynamic/Standard/Soft/ Personal.

Color mode: This item can adjust the saturation of the color based on your own like.

Zoom mode: Four selectable Zoom Modes, Normal, Zoom, Cinema, Wide .

3DNR: Used for the noise reduction adjustment to get a better image effects.

DLC: Dynamic brightness control

AUDIO

Press **MENU** button to display the main menu.

Press ◀ / ▶ button to select **AUDIO** in the main menu, it will highlight the first option.

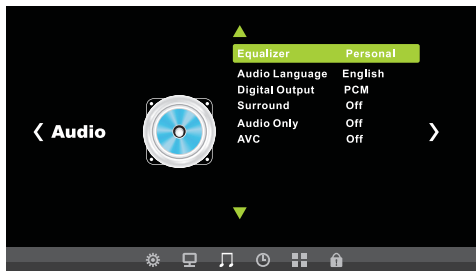

AUDIO MENU

Press **MENU** to display the main menu, and press ◀ / ▶ to select the Sound Menu.

Equalizer Standard: Adjust audio frequency band.

MTS: Set the MTS (ATV mode).

Audio Language: Set the language (DTV mode).

Digital Output: Press ▼ button to highlight Digital Output. then press the enter button to select it .

Surround Sound: Surround effect on or off.

Audio Only: Audio Only effect on or off.

AVC: When set the AVC on, quick volume change will be smoothed.

OSD Menu Operations

TIME

Press **MENU** button to display the main menu.

Press ◀ / ▶ button to select **TIME** in the main menu, it will highlight the first option.

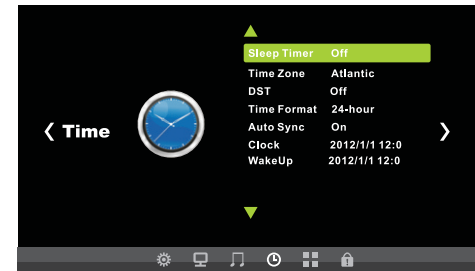

TIME MENU

Press **MENU** to display the main menu, and press ◀ / ▶ to select the Time Menu.

Sleep Timer: Select the time in minutes (5min, 10min, 15min, 30min, 60min, 90min, 120min, 180min, 240min, Personal) that you want the TV to shut off automatically after you set the time. Cancel by setting it to Off.

Time Zone: Set to choose the time belt.

Time Format: Set to choose time display format

Auto Sync: Synchronous automatic

Clock: Press ENTER to set time.

Wake Up: Ending the state of sleep

SETUP

Press **MENU** button to display the main menu.

Press ◀ / ▶ button to select **SETUP** in the main menu, it will highlight the first option.

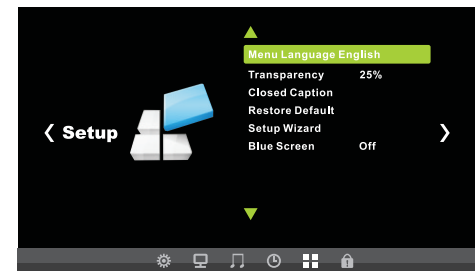

SETUP MENU

Press **MENU** to display the main menu, and press ◀ / ▶ to select the Setup Menu.

Menu Language: Set the OSD display language. (English/ French/ Spanish)

Transparency: Set transparency of OSD.

Closed Caption: Set to hide the caption

Restore Default: Recall the default setting.

Setup Wizard: Installation guide.

Blue Screen: Set the background color to blue or black when no input signal.

OSD Menu Operations

LOCK

Press **MENU** button to display the main menu.

Press **◀ / ▶** button to select **LOCK** in the main menu, it will highlight the first option.

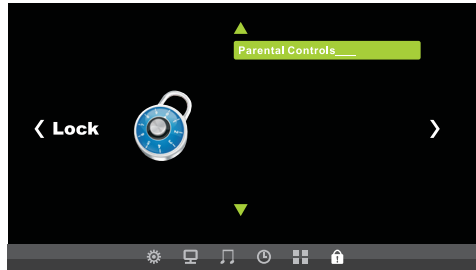

Press **MENU** button to display the main menu.

Press **◀ / ▶** button to select **Lock** in the main menu. It will highlight the first option.

Enter the code 0000 to enter the parental menu (see the picture below), or press **MENU** to cancel.

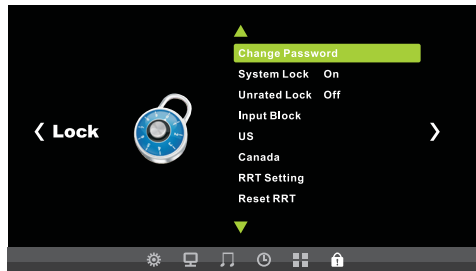

CHANGE PASSWORD

Press **ENTER** button and enter a new 4 digit password.

SYSTEM LOCK

Press **ENTER** to select the system lock on or off.

UNRATED LOCK

Press **ENTER** to select the Unrated lock on or off.

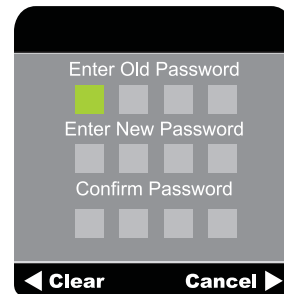

OSD Menu Operations

INPUT BLOCK

Press **ENTER** to display the Input Block, Press **▼ / ▲** button to select (TV, AV, Component, DVD, HDMI1, HDMI2, PC, USB) press **◀ / ▶** button to select "UnBlock" or "Block".

US

Press **ENTER** or right arrow for to enter to US ratings menu, which contains two sub-menus: Movie Rating and TV Rating.

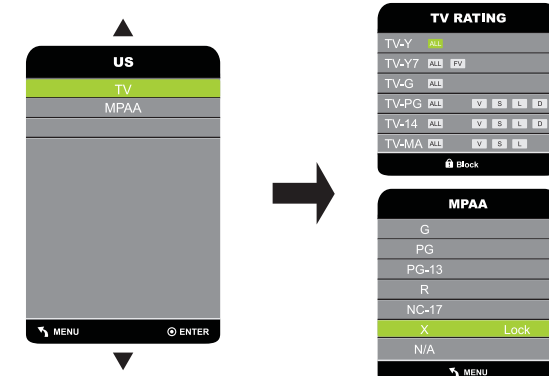

CANADA

Press **ENTER** or right arrow for to enter to CANADA ratings menu, which contains two sub-menus: Canada English and Canada French.

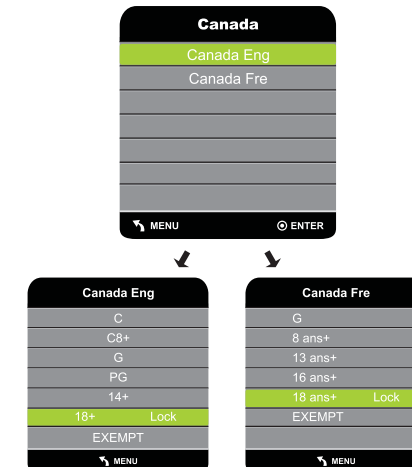

USB

USB Operation

Note: Before operating Media menu, Plug in USB device, then press SOURCE button to set the Input Source to USB.

Press ◀ / ▶ button to select Photo/Music, and then press ENTER button to enter.



Choose PHOTO to enter the photo scan model, if there are many zones in mobile equipment, it would shown below:

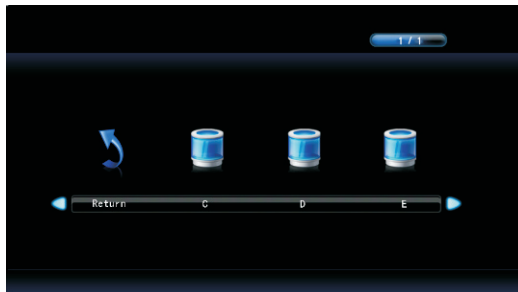

Choose C zone, can scan the folder and photos.

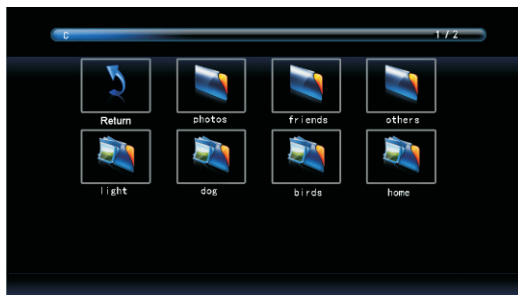

Selected the photos, press Enter to show slides, press the Enter again will show the toolbar of menu, as shown, can do various operating to the show slides, for example: suspend, stop, play music etc.

USB

USB Operation



Enter the model of scanning music can scan the music files, as shown below:

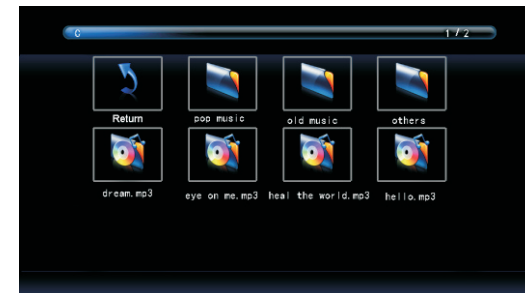

Pitch up the MP3 files, press Enter to play, as shown below, can setup the playing more belong to the toolbar, such as: suspend, fast forward, fall speed, loop, etc.

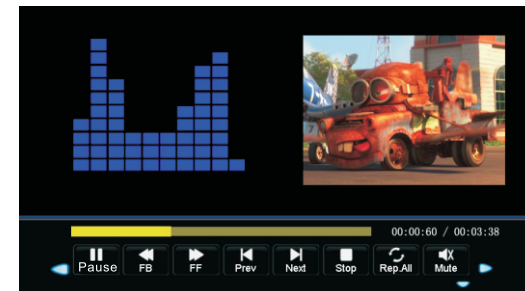

Press ◀ / ▶ to select the different menu pages.
Press the remote control of ENTER to turn into the selected sub menu.
Press the remote control of MENU to come back the User's operation menu or quit.
Press the remote control of EXIT to exit menu directly.

USB

USB Operation



Press ◀ / ▶ to select the different menu **Movie**.
 Press the remote control of **ENTER** to turn into the selected sub menu.
 Press the remote control of **MENU** to come back the User's operation menu or quit.
 Press the remote control of **EXIT** to exit menu directly.

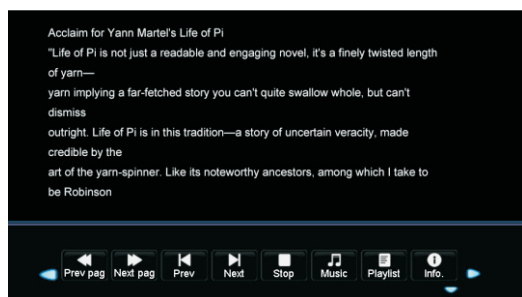

Press ◀ / ▶ to select the different menu **TEXT**.
 Press the remote control of **ENTER** to turn into the selected sub menu.
 Press the remote control of **MENU** to come back the User's operation menu or quit.
 Press the remote control of **EXIT** to exit menu directly.

USB

MULTIMEDIA FORMATS	
Photo	JPG/JPEG
Movie	MPEG2/MPEG2-HD/MPEG4/MPEG4-HD/H.264/FLV/MVC/DD
Music	MP3
Text	TXT

DVD Setup Menu

INITIAL SETTING(DVD)

General Settings page

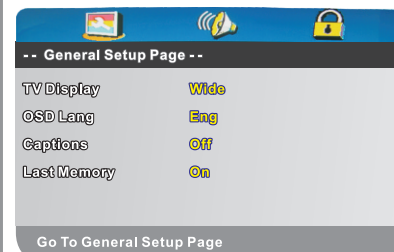

- 1. TV DISPLAY:** Set the ratio of output to the television signal options are: Normal/PS(4:3 Pan Scan), Normal/PS (4:3 Letter Box), Wide the current default settings is wide.
- 2. OSD Lang:** Set the OSD Language options.
- 3. CAPTION:** Play the enclosed captions on some DVD titles, Optional setting: ON/OFF.
- 4. LAST MEMORY:** Save the last to open with the related options are: ON/OFF.

Audio Setup Page

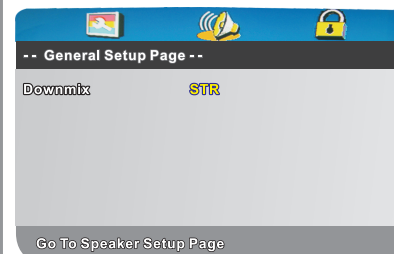

- 1. LT/RT:** Logic Surround stereo audio output. This matrix-based coding process enables stereo audio tracks to carry four channels(left, center, right and surround) of audio data.
- 2. Stereo:** Analog stereo audio output. The player sends the subwoofer and speech signals to your front right and front left speakers.

Preference Page

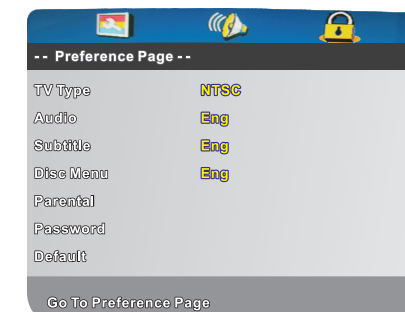

- 1. TV Type:** This product supports output of various system, including Multi, NTSC, PAL.

- PAL:** Choose this settings if your DVD player is connected to a PAL TV. The default setting is PAL: **NTSC:** Choose this settings if your DVD player is connected to a NTSC TV.
MULTU: Choose this settings if your DVD player is connected to a multi-system TV.
- 2. Audio:** DVD built-in disc dubbing language selection options.
 - 3. Subtitle:** This player provides English etc, languages as the built-in subtitle language, when playing DVD, user may hide the subtitle or choose any of them as the present subtitle language.
 - 4. Disc menu:** DVD Disc language selection options.
 - 5. PARENTAL[DVD only]:** This is to disable the playing of specified DVDs which are unsuitable for children. Some DVDs are encoded with specific rating level.
 If the rating level of the disc is higher than that preset in the setup operation, playback of the disc will be prohibited. After selecting one of the PARENTAL items the screen will change to the PASSWORD page, and password is 8888.
 - 6. PASSEORD[DVD only]:** Change the PASSWORD.
 - 7. Default:** This option will resume the original settings of this player.

DVD OPERATION

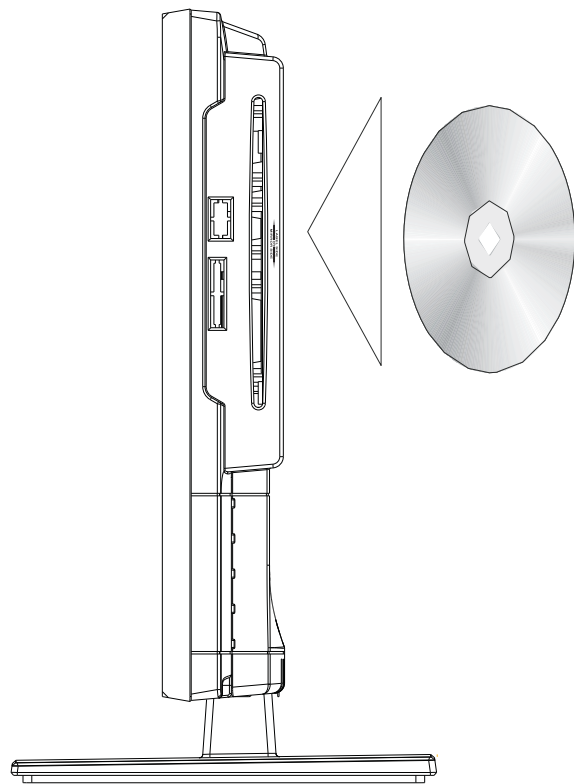

DVD Support List:

Media Type	Format	Remark
Video	*.MPG,*.DAT	MPEG-1/2
	*.VOB	MPEG-2 MP@ML
	*.AVI	Xvid

Troubleshooting

If you have any problem, check the countermeasures for each symptom listed below. The following symptoms may have caused by inappropriate adjustment rather than actual malfunction of the unit. If the trouble persists, contact the service center.

Symptoms	Possible solutions
No power	Please check the power cord is plugged in. Unplug the power cord and plug it after 60 seconds and restart the TV.
No picture	Please check antenna connection. Station may experience problems, please tune to another station. Please adjust the settings of contrast and brightness.
Good picture but no sound	Please increase the volume. Please check TV is under mute mode, press MUTE button on the remote control. Please check sound settings.
Good sound but abnormal color or no picture	Please check the antenna connection.
No remote control	Batteries of remote control may have been exhausted, if necessary, please change the batteries. Clean the remote control lens. The distance between LED TV and remote control should be within 8m.
Full screen flickering under VGA	V-HEIGHT value may be set too big, restart computer and enter safe mode, then set monitor parameters to correct value according to adjustment description.
Horizontal stripes under VGA	Sample phase may be deflected, adjust phase according to picture position.
Colored dots may be present on the screen	This product is the high resolution LED display device and a few cell defects can occur in the manufacture of the LED. Several colored dots visible on the screen would be acceptable. in line with other LED manufacturers and would not mean that the LED is faulty. We hope you will understand that it could not be changed or refunded.

Picture defects and the reason



Snowy Picture

Snowy picture is usually due to weak signal. Adjust antenna or install an antenna amplifier.



Double Image or Ghosts

Double images are usually caused by reflections from tall buildings. Adjust the direction of the antenna or raise it.



Radio Wave Interference

Wave patterns are moving on the screen, which are usually caused by nearby radio transmitters or short-wave receiving equipment.



High Temperature Electrothermal Interference

Diagonal or herringbone patterns appear on the screen or part of picture is missing. This is probably caused by high temperature electrothermal equipment in a nearby hospital.